

IPANDEE

Installation And Operation Manual

MPPT

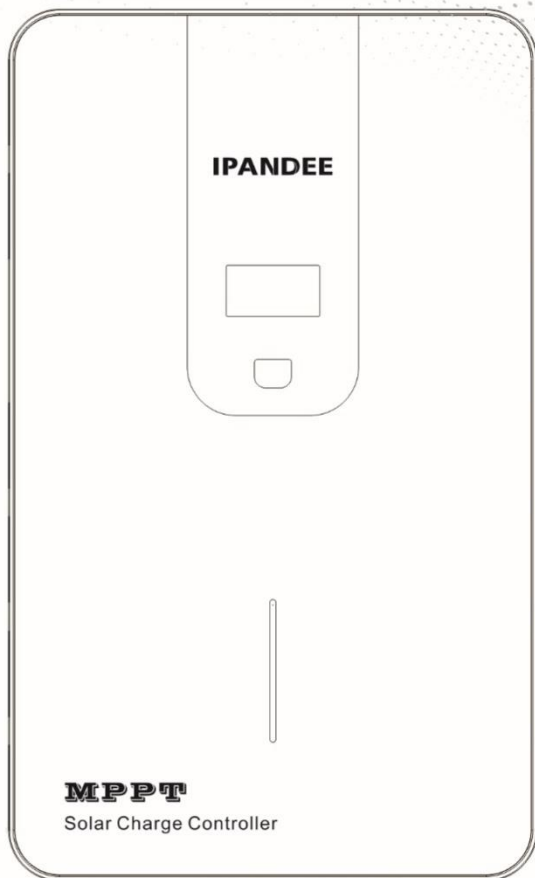

MPPT

Acid

Li

SOLAR CHARGE CONTROLLER

RUNNER-RS

DIMENSIONS

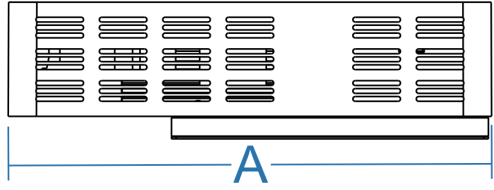
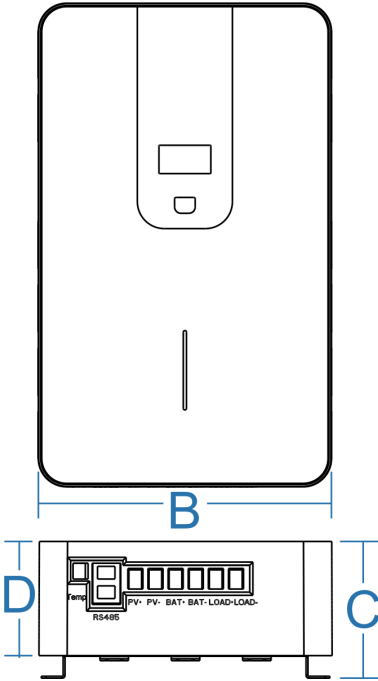

Type		RS48L40	RS48L50	RS48L60	RS48L80	RS48L100
A	mm	305	305	305	380	380
	in	12.01	12.01	12.01	14.97	14.97
B	mm	185	185	185	210	210
	in	7.29	7.29	7.29	8.28	8.28
C	mm	90	90	90	98	98
	in	3.54	3.54	3.54	3.86	3.86
D	mm	72	72	72	80	80
	in	2.84	2.84	2.84	3.15	3.15

SPECIFICATION SUMMARY

Type	Nominal Battery Voltage	Max.PV Open-Circuit Voltage*	Nominal Max.Input Power**	Max.Battery Charging Current	Rated Load Current
RS48L40	12/24/36/48V	150V	560/1120/1680/2240W	40A	30A
RS48L50	12/24/36/48V	150V	700/1400/2100/2800W	50A	30A
RS48L60	12/24/36/48V	150V	840/1680/2520/3360W	60A	30A
RS48L80	12/24/36/48V	150V	1120/2240/3360/4480W	80A	50A
RS48L100	12/24/36/48V	150V	1400/2800/4200/5600W	100A	50A

*Array voltage should never exceed this limit.

**These power limits refer to the maximum wattage the MPPT can manage. Higher power arrays can be used without damaging the controller.

TABLE OF CONCENTS

1.0 Important Safely Instructions	1
2.0 General Information	4
2.1 Features	4
2.2 Attached Accessories	4
2.3 Optional Accessories	5
3.0 Installation Instructions	6
3.1 General Installation Notes	6
3.2 Mounting	7
4.0 Operation	9
4.1 Max Power Point Tracking Technology	9
4.2 Battery Charging	10
4.3 Load Control Information	11
4.4 LED Indications	12
4.5 Button And Display	13
5.0 Trouble Shooting	14
6.0 Technical Specifications	15

1.0 IMPORTANT SAFETY INSTRUCTIONS

SAVE THESE INSTRUCTIONS.

This manual contains important safety, installation, and operating for the MPPT solar controller.

The following symbols are used throughout this manual to indicate potentially dangerous conditions or mark important safety instructions:



WARNING: Indicates a potentially dangerous condition. Be careful when performing related operations.



CAUTION: Indicates a critical procedure for safe and proper operation of the controller.



NOTE: Indicates a procedure or function that is important to the safe and proper operation of the controller.

Safety Information

- Read all of the instructions and cautions in the manual before installation.
- There are no user serviceable parts inside the MPPT. Do not disassemble or attempt to repair the controller



WARNING: *Risk Of Electrical Shock. NO POWER OR ACCESSORY TERMINALS ARE ELECTRICALLY ISOLATED FROM DC INPUT, AND MAY BE ENERGIZED WITH HAZARDOUS SOLAR VOLTAGE. UNDER CERTAIN FAULT CONDITIONS, BATTERY COULD BECOME OVER-CHARGED. TEST BETWEEN ALL TERMINALS AND GROUND BEFORE TOUCHING.*



WARNING: *THE COMMUNICATION PORT IS NOT AN ISOLATION SOURCE AND ISOLATION SIGNAL. PLEASE BE CAREFUL WHEN CONNECTING WITH OTHER EQUIPMENT.*

- External solar and battery disconnects are required.
- Disconnect all sources of power to the controller before installing or adjusting the MPPT.

Installation Safety Precautions



WARNING: *This unit does not contain GFDI device.*

- Mount the MPPT indoors. Prevent exposure to the elements and do not allow water to enter the controller.
- Install the MPPT in a location that prevents casual contact. The MPPT heatsink can become very hot during operation.
- Use insulated tools when working with batteries.
- Avoid wearing jewelry during installation.
- The battery bank must be comprised of batteries of same type, make, and age.
- Do not smoke near the battery bank.
- Power connections must remain tight to avoid excessive heating from a loose connection.
- Use properly sized conductors and circuit interrupters.
- The grounding terminal is located at the bottom of the case.

The MPPT controller must be installed by a qualified technician in accordance with the electrical regulations of the country of installation.

A means of disconnecting all power supply poles must be provided. These disconnects must be incorporated in the fixed wiring.

The MPPT negative power terminals are common, and must be grounded as instructions, local codes, and regulations require.

A permanent, reliable earth ground must be established with connection to the MPPT ground terminal.

The grounding conductor must be secured against any accidental detachment.

Battery Safety



WARNING: *A battery can present a risk of electrical shock or burn from large amounts of short-circuit current, fire, or explosion from vented gases. Observe proper precautions.*



WARNING: *Risk of Explosion. Proper disposal of batteries is required. Do not dispose of batteries in fire. Refer to local regulations or codes for requirements.*



CAUTION: *When replacing batteries, use properly specified number, sizes, types, and ratings based on application and system design.*



CAUTION: *Do not open or mutilate batteries. Released electrolyte is harmful to skin, and may be toxic.*

- Servicing of batteries should be performed, or supervised, by personnel

knowledgeable about batteries, and the proper safety precautions.

- Be very careful when working with large lead-acid batteries. Wear eye protection and have fresh water available in case there is contact with the battery acid.
- Remove watches, rings, jewelry and other metal objects before working with batteries.
- Wear rubber gloves and boots.
- Use tools with insulated handles and avoid placing tools or metal objects on top of batteries.
- Disconnect charging source prior to connecting or disconnecting battery terminals.
- Determine if battery is inadvertently grounded. If so, remove the source of contact with ground. Contact with any part of a grounded battery can result in electrical shock. The likelihood of such a shock can be reduced if battery grounds are removed during installation and maintenance (applicable to equipment and remote battery supplies not having a grounded supply circuit).
- Carefully read the battery manufacturer's instructions before installing / connecting to, or removing batteries from, the MPPT.
- Be very careful not to short circuit the cables connected to the battery.
- Have someone nearby to assist in case of an accident.
- Explosive battery gases can be present during charging. Be certain there is enough ventilation to release the gases.
- Never smoke in the battery area.
- If battery acid comes into contact with the skin, wash with soap and water. If the acid contacts the eye, flood with fresh water and get medical attention.
- Be sure the battery electrolyte level is correct before starting charging. Do not attempt to charge a frozen battery.
- Recycle the battery when it is replaced.

2.0 GENERAL INFORMATION

2.1 Features

The features of the MPPT are shown in below. An explanation of each feature is provided.

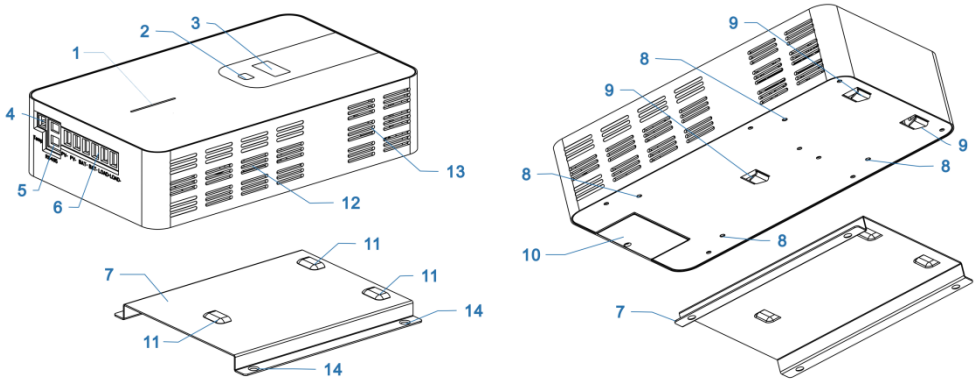

- 1 – Indicator light
- 2 – Function button
- 3 – Digital OLED display
- 4 – Temperature sensor terminals
- 5 – Dual RJ45 serial communication ports
- 6 – Input and output terminals (PV+/PV-/BAT+/BAT-/LOAD+/LOAD-)
- 7 – Install the hanging plate subassembly
- 8 – Reverse fixing hole
- 9 – Install the hook
- 10 – Terminal cover plate
- 11 – Install hanging slot
- 12 – Cooling air duct inlet
- 13 – Cooling air duct outlet
- 14 – Install hole for mounting hanging plate

2.2 Attached Accessories

- 1 – Install hanging plate
- 2 – Temperature sensing cable
- 3 – Plastic expansion particles

- 4 – M4 screws
- 5 – User manual

2.3 Optional Accessories

The following accessories are available for purchase separately from your authorized dealer:

MH-M80(Meter)

The digital Remote Meter displays system operating information, error indications. Information is displayed on an OLED display. Additionally, 3 status LEDs provide system status at a glance. The Meter can easily set the parameters of the controller. The meter can be flush mounted in a wall or surface mounted using the mounting frame (included). The **MH-M80** is supplied with 4.9 ft (1.5 m) of cable (Can be extended), a mounting frame, and mounting screws. The **MH-M80** connects to the RJ-45 port on the MPPT. The **MH-M80** cannot be used with other's outside device.

MH-S80(Meter)

The digital Remote Meter displays system operating information, error indications. Information is displayed on an OLED display. The Meter can easily set the parameters of the controller. The Meter can be connected to 4 controllers at most, and the controllers of the same battery system can work in parallel. The meter can be flush mounted in a wall or surface mounted using the mounting frame (included). The **MH-S80** is supplied with 4.9 ft (1.5 m) of cable (Can be extended), a mounting frame, and mounting screws. The **MH-S80** connects to the RJ-45 port on the MPPT. The **MH-S80** cannot be used with other's outside device.

USB-RS485 Cable

The USB-RS485 cable converts the RJ45 electrical interface to a standard USB interface which enables communication between the MPPT and a personal computer (PC). The cable can be used for programming custom charging setpoints, and for logging data in SolarMate. The cable cannot be used with other's outside device.

BT-02

A modular wiring box that can be added to MPPT controller. The box acts as a transmitter (Near field remote control), users can use the mobile app to control the MPPT through bluetooth. The wire box cannot be used with other's outside device.

Cloud-Box-M2

A modular wiring box that can be added to MPPT controller. The box acts as a transmitter (Cloud remote control), users can use the mobile APP to control the MPPT through internet. The wire box cannot be used with other's outside device.

3.0 INSTALLATION INSTRUCTIONS

3.1 General Installation Notes

- Read through the entire installation section first before beginning installation.
- Be very careful when working with batteries. Wear eye protection. Have fresh water available to wash and clean any contact with battery acid.
- Use insulated tools and avoid placing metal objects near the batteries.



WARNING: *Never install the MPPT in an enclosure with vented/flooded batteries. Battery fumes are flammable and will corrode and destroy the MPPT circuits.*



CAUTION: *When installing the MPPT in an enclosure, ensure sufficient ventilation. Installation in a sealed enclosure will lead to over-heating, reduced power operation and a decreased product lifetime.*

- Do not install in locations where water can enter the controller.
- Loose power connections and /or corroded wires may result in resistive connections that melt wire insulation, burn surrounding materials, or even cause fire. Ensure tight connections and use cable clamps to secure cables and prevent them from swaying in mobile applications.
- Preset charging profiles are generally designed for common batteries. Custom settings can be used for varied charging requirements (see sections 4.2 for details).
- The MPPT battery connection may be wired to one battery, or a bank of batteries.
- The MPPT prevents reverse current leakage at night, so a blocking diode is not required in the system.
- The MPPT is designed to regulate ONLY solar (photovoltaic) power. Connection to any other type of power source e. g. wind turbine or generator may void the warranty.



WARNING: *Solar and battery fuses or DC breakers are required in the system. These protection devices are external to the MPPT controller.*



WARNING: *Installation must comply with Electrical Code requirements. Breakers and fuses may require lower ratings than referenced, so as not to exceed any specific wire ampacity.*

3.2 Mounting

Inspect the controller for shipping damage. Do not install directly over an easily combustible surface since the heat sink may get hot under certain operating conditions.

For proper air flow, allow at least 15 cm (6 in) of space around the controller. Do not locate in an enclosure where battery gases can accumulate.



NOTE: The heat sink must be in a vertical position (fins up and down).

STEP 1: Check Controller Limitations

Verify that the highest temperature compensated solar array open-circuit voltage (Voc), and load current do not exceed the ratings of the MPPT version being installed. Multiple controllers can be installed in parallel on the same battery bank to achieve greater total charging current. In this type of system, each MPPT must have its own solar array. The load terminals of multiple controllers can only be wired together if the total load draw does not exceed the nameplate current of the LOWEST rated controller.

STEP 2: Make holes on the mounting wall

The dimensions of L1 and L2 are shown on the right. Measure and mark the distance on the installation wall, drill four holes with diameter of 6mm, and fill the four holes with plastic expansion particles.

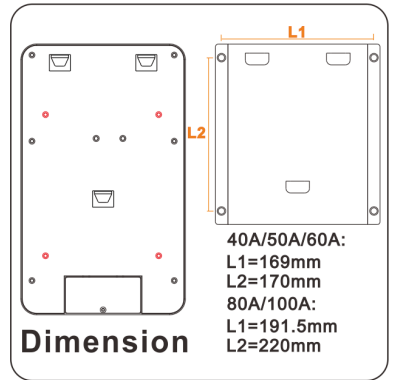
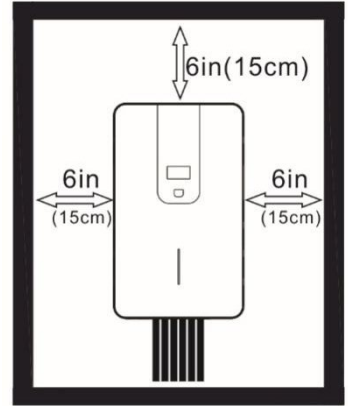
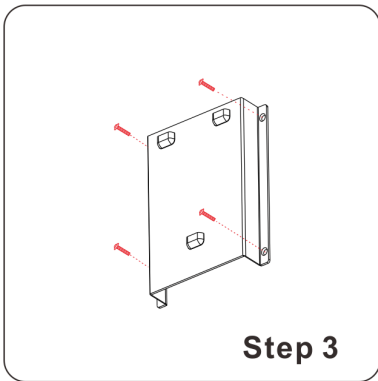

STEP 3: Fix the mounting hanging plate on the wall

As shown in the left figure, align the four mounting holes of the hanging plate with the mounting holes in step 2, and use screws (or other screws of appropriate specifications) to fix the mounting hanging plate on the wall.

STEP 4: Connect the input and output power cables

Before wiring, the sealing cover on the back of the controller must be opened with a screwdriver, and then the wiring shall be carried out according to the correct wiring

sequence and the screws shall be tightened. After confirmation, the sealing cover shall be installed.

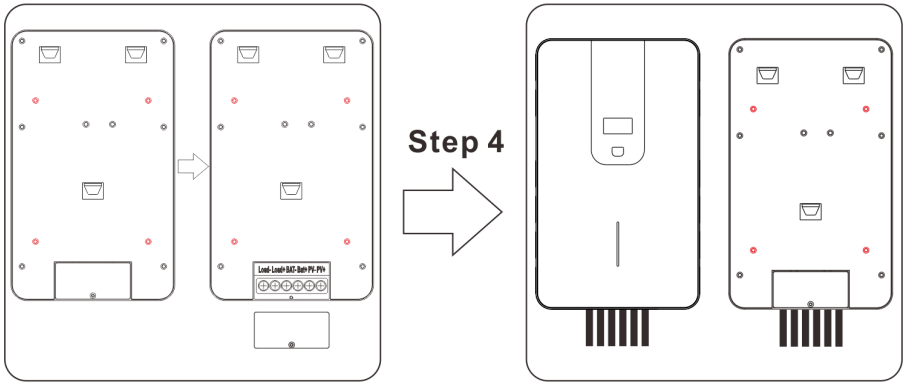

STEP 5: Fix the controller on the mounting hanging plate

Align the hook on the controller backplane connected in step 4 with the hanging slot of the wall mounted hanging plate, so that the hook and the hanging slot can be combined normally, ensure that the controller is fixed well without shaking, and the installation of the controller is completed.

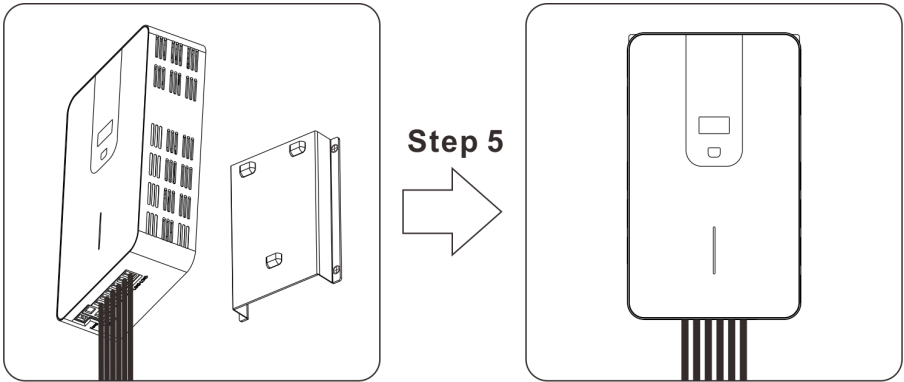

STEP 6: Power on and start working

Check that the solar panel and battery are in normal condition, and then switch on in the order of first battery and then solar panel.

 **NOTE:** Before connecting the battery, measure the open-circuit voltage. It must be over 10 volts to start the controller. If the system voltage is set to Auto-detect, battery voltage over 18V will be detected as a 24V nominal battery, and the unit will charge accordingly. The 12/24/36/48V auto selection is only done at start-up.



Warning: Risk of damage

Disconnect the battery from the MPPT after the solar input is disconnected as far as possible. If the battery is removed during MPPT charging, there is a certain probability that the controller will be damaged.

To prevent damage, the power must be cut off under the following conditions:

Reverse order as power-up.

4.0 OPERATION

4.1 Max Power Point Tracking Technology

Power is the product of voltage and current (Volts x Amps), the following is true*:

(1) Power Into the MPPT = Power Out of the MPPT

(2) Volts In x Amps In = Volts Out x Amps Out

* assuming 100% efficiency i.e. if no losses in wiring and conversion existed.

If the solar module's V_{mp} is greater than the battery voltage, it follows that the battery current must be proportionally greater than the solar input current so that input and output power are balanced. The greater the difference between the maximum power voltage and battery voltage, the greater the current boost.

Higher solar input voltage results in lower solar input current for a given input power. High voltage solar input strings allow for smaller gauge solar wiring. This is especially helpful for systems with long wiring runs between the solar array and the MPPT.

An Advantage Over Traditional Controllers Traditional controllers connect the solar module directly to the battery when recharging. This requires that the solar module operate in a voltage range that is below the module's V_{mp} . In a 12V system, for example, the battery voltage may range from 10 - 15 Vdc but the module's V_{mp} is typically around 17V. The figure below shows a typical current vs. voltage output curve for a nominal 12V charging system.

12 Volt Module Current vs. Voltage

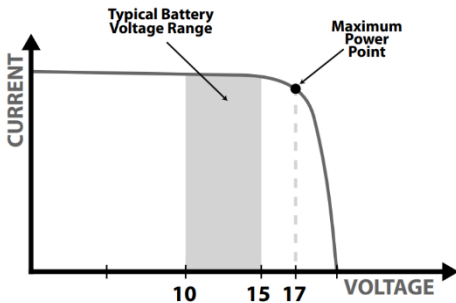

12 Volt Module Output Power

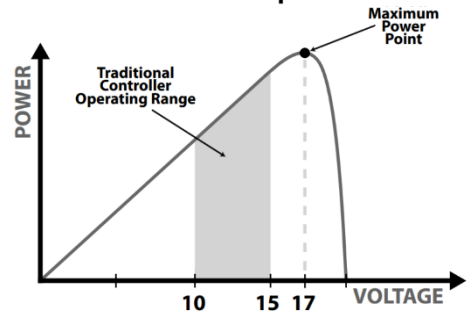

4.2 Battery Charging

Charging lead-acid batteries

The MPPT has a 4-stage battery charging algorithm for rapid, efficient, and safe battery charging.

1 - **CC Stage** (Constant Current Charging): Fast Charging

2 - **CV Stage** (Constant Voltage Charging): Absorption Charging

3 - **CF Stage** (Floating Charging): Protect the battery from long-term overcharge. And make up the loss of self-discharge

4 - **Equalization Stage**: Activate battery chemical reaction

Charging Lithium ion batteries

The MPPT will charge according to the specifications of lithium-ion battery, which is mainly divided into two stages. First stage, when the battery voltage is less than the saturation voltage, it will charge quickly, and the second stage, when the battery voltage is equal to the saturation voltage, it will absorb charge.

Battery Charge Setting

Charging parameters of lead-acid battery. All voltage settings listed are for nominal 12 Volt batteries. Multiply the voltage settings by two (2) for 24 Volt batteries. Multiply the voltage settings by three (3) for 36 Volt batteries. Multiply the voltage settings by four (4) for 48 Volt batteries.

Battery Charging Set-points (@ 25°C):

Bat Type	CV (volts)	CF (volts)	Equalize (volts)	Equalize (minutes)	Undervoltage protection	Undervoltage Recovery
Gel	14.2	13.8	14.2	30	11.1	12.6
Sealed	14.4	13.8	14.6	30	11.1	12.6
Flooded	14.6	13.8	14.8	30	11.1	12.6
AGM	14.1	13.7	14.4	30	11.1	12.6
Custom	Custom	Custom	Custom	30	Custom	Custom

Charging parameters of lithium ion battery.

Bat Type	Nominal Voltage	Saturation Voltage	Cut-off Voltage	Cut off recovery
LiFePO4-4s	12.8	14.4	10.8	12.4

LiFePO4-7s	22.4	25.2	18.9	21.7
LiFePO4-8s	25.6	28.8	21.6	24.8
LiFePO4-10s	32	36	27	31.0
LiFePO4-15s	48	54	40.5	46.5
LiFePO4-16s	51.2	57.6	43.2	49.6
Ternary-3s	11.1	12.6	9.6	10.5
Ternary-6s	22.2	25.2	19.2	21
Ternary-7s	25.9	29.4	22.4	24.5
Ternary-10s	37	42	32	35
Ternary-13s	48.1	54.6	41.6	45
Ternary-14s	51.8	58.8	44.8	49
Custom	Custom	Custom	Custom	Custom



NOTE: *These settings are general guidelines for use at the operator's discretion. The MPPT can be set to satisfy a wide range of charging parameters. Consult the battery manufacturer for optimal battery charge settings.*

4.3 Load Control Information

The primary purpose of the load control function is to disconnect system loads when the battery has discharged to a low state of charge, and reconnect system loads when the battery is sufficiently recharged. System loads may be lights, DC appliances, or other electronic devices. The total current draw of all loads must not exceed the MPPT 30 or 50 Amp maximum load rating.



CAUTION: *Equipment Damage*

Do not wire any AC inverter to the load terminals of the MPPT. Damage to the load control circuit may result. An inverter should be wired to the battery. If there is a possibility that any other load will sometimes exceed the maximum voltage or current limits, the device should be wired directly to the battery or battery bank.

General Load Control Notes:

Do not wire multiple MPPT load outputs together in parallel to power DC loads with a current draw greater than 30 or 50A, depending on the MPPT model in use.

Equal current sharing cannot be assured and an over-load condition will likely occur on one or more controllers.

Exercise caution when connecting loads with specific polarity to a live load circuit. A reverse polarity connection may damage the load. Always double

check load connections before applying power.

The load output voltage range is the same as battery pack. For example, if the battery's voltage is 25.2V, the instant load output voltage is 25.2V, too.

It can supply power to load output continuously if the load output current is within the rated range.

When the load output working current is 100%-120% of rated current for 5 mins, load output will be OFF.

As soon as load output working current is over 120% of rated current, the load output will be OFF immediately.

 **NOTE:** To restart load output, user should set Load Type to "ON" or others manually through controller / APP/Remote meter / PC.

Load Control Modes:

1 – ON/OFF Mode: The state of being on or off.

2 – Light (PV) Control Mode: On and off according to whether there is sunlight. Refer to the model shown in the figure.

3 – Dual-timer Interval Control Mode: On and off by two timers. Refer to the model shown in the figure.

4 – Time & Light (PV) Control Mode: On and off according to sunlight in hours.

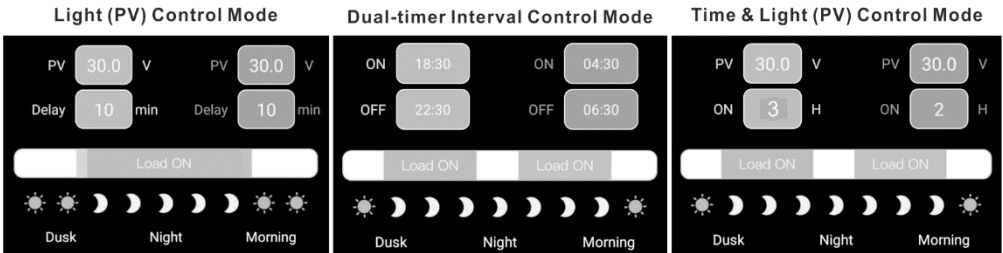

 **Note:** Only ON/OFF mode can be set on the controller, and others need to be set through optional accessories.

 **Note:** ON/OFF mode can be set, refer to [4.5](#)

4.4 LED Indications

Green: When this color appears, it indicates that the load output is normally on. When switched to ON mode, the LED indicator will be on for 2 seconds and then return to normal indication.

Bule: When this color appears, it indicates that it is in charging state.

5.0 TROUBLE SHOOTING



WARNING: RISK OF ELECTRICAL SHOCK.

NO POWER OR ACCESSORY TERMINALS ARE ELECTRICALLY ISOLATED FROM DC INPUT, AND MAY BE ENERGIZED WITH HAZARDOUS SOLAR VOLTAGE. UNDER CERTAIN FAULT CONDITIONS, BATTERY COULD BECOME OVERCHARGED. TEST BETWEEN ALL TERMINALS AND GROUND BEFORE TOUCHING.



WARNING: Shock Hazard

A means of disconnecting all power supply poles must be provided. These disconnects must be incorporated in the fixed wiring. Open all power source disconnects before removing controller wiring cover, or accessing wiring.

Problem:

No LED indications, controller does not appear to be powered

Solution:

With a multi-meter, check the voltage at the battery terminals on the MPPT. Battery voltage must be 10 vdc or greater. If the voltage on the battery terminals of the controller is between 10 and 35 vdc, and no LEDs are lit, contact your authorized dealer for service. If no voltage is measured, check wiring connections, fuses, and breakers.

Problem:

The MPPT is not charging the battery.

Solution:

Check the fuses, breakers, and wiring connections in the power source wiring. With a multi-meter, check the array voltage directly at the MPPT solar input terminals. Input voltage must be greater than battery voltage before charging will begin.

Check whether the battery voltage in OLED is in the range of controller system recognition.

Problem:

The battery is in a low energy or empty for a long time.

Solution:

Possible reasons: 1. Solar panels quantity are too less to generate enough energy, increase solar panels quantity.

2. Battery capacity is too small to store enough energy, increase battery capacity.

States Description

Display In Oled	Description
Normal Run	No fault
HS Over	Heatsink overheating
PV Low	Low input voltage
BAT Low	Battery low
BAT Over	Battery Over
PV Over	Over input voltage
CHG Over	Charging overcurrent
DisC. Over	Discharging overcurrent

6.0 TECHNICAL SPECIFICATIONS

Common Negative MPPT Controller					
Model:	RS48L40	RS48L50	RS48L60	RS48L80	RS48L100
Electrical:					
Nominal Battery Voltage	12 / 24 / 36 / 48 Vdc				
Battery Voltage Range	9 ~ 60Vdc				
Voltage Accuracy	< +/- 0.2V				
Max.Battery Current	40A	50A	60A	80A	100A
Max.PV Open-Circuit Voltage	150V				
Load Current Rating	30A			50A	
Self-Consumption	1~2W				
Conversion Efficiency (Peak)	97%				
Mechanical:					
Dimensions (Net)	305*185*72 (MM)			380*210*80 (MM)	
Dimensions (Pack)	370*218*98 (MM)			490*350*195 (MM)	
Weight (Net)	2.0			5.0	
Weight (Pack)	2.5			6.1	
Max.Wire Size	25mm ² / #4 Awg			50mm ² / #1 Awg	

Data & Communications	
Communication Port	Dual RJ45
Comm.Protocols	Private protocol and Modbus
PC Software	SolarMate
Meter	MH-M80 / MH-S80
Dry Contact Access Voltage	Via RJ45 port
Environmental:	
Ambient Temperature Range	-30°C ~ +50°C
Storage Temperature	-30°C ~ +80°C
Humidity	90% n.c.
IP (Ingress protection)	IP21

Protections

Reverse Polarity - battery and array
Solar Short-Circuit
High Heatsink Temperature - Current De-rating
Load Short-Circuit
Load Over-Current
Heatsink Temperature Limit
Over-volt / low-volt protection
Battery shedding

Wire Sizing Charts

2% Voltage Drop Charts for 75°C Stranded Copper Wire

1-Way Wire Distance (feet), 12 Volt System									
Wire Size (AWG)	100A	90A	80A	70A	60A	50A	40A	30A	20A
2/0*	13.4	14.9	16.8	19.2	33.6	38.4	44.8	53.8	67.2
1/0*	10.6	11.8	13.3	15.2	17.7	21.3	26.6	35.5	53.2
2	6.7	7.5	8.4	9.6	11.2	13.4	16.8	22.4	33.6
4	4.2	4.7	5.3	6.1	7.1	8.5	10.6	14.1	21.2
6	2.6	2.9	3.3	3.8	4.4	5.3	6.6	8.8	13.2

8	1.7	1.9	2.1	2.4	2.8	3.4	4.2	5.6	8.4
10	1.0	1.2	1.3	1.5	1.7	2.1	2.6	3.5	5.2
1-Way Wire Distance (meters), 12 Volt System									
Wire Size (mm ²)	100A	90A	80A	70A	60A	50A	40A	30A	20A
70*	4.1	4.6	5.1	5.9	6.8	8.2	10.2	13.7	20.5
50*	3.2	3.6	4.1	4.6	5.4	6.5	8.1	10.8	16.2
35*	2.0	2.3	2.6	2.9	3.4	4.1	5.1	6.8	10.2
25	1.3	1.4	1.6	1.8	2.1	2.6	3.2	4.3	6.4
16	0.8	0.9	1.0	1.2	1.3	1.6	2.0	2.7	4.0
10	0.5	0.6	0.6	0.7	0.8	1.0	1.3	1.7	2.5
6	0.3	0.4	0.4	0.5	0.5	0.6	0.8	1.1	1.6

Maximum 1-way wire distance for 12 Volt systems, stranded copper, 2% voltage drop

2% Voltage Drop Charts for 75°C Solid Copper Wire

1-Way Wire Distance (feet), 12 Volt System									
Wire Size (AWG)	100A	90A	80A	70A	60A	50A	40A	30A	20A
2/0*	16.7	18.5	20.9	23.8	27.8	33.4	41.7	55.6	83.4
1/0*	13.2	14.7	16.6	18.9	22.1	26.5	33.1	44.1	66.2
2	8.3	9.2	10.4	11.9	13.9	16.6	20.8	27.7	41.6
4	5.2	5.8	6.6	7.5	8.7	10.5	13.1	17.5	26.2
6	3.3	3.6	4.1	4.7	5.5	6.6	8.2	10.9	16.4
8	2.1	2.3	2.6	3.0	3.5	4.2	5.2	6.9	10.4
10	1.3	1.5	1.7	1.9	2.2	2.6	3.3	4.4	6.6
1-Way Wire Distance (meters), 12 Volt System									
Wire Size (mm ²)	100A	90A	80A	70A	60A	50A	40A	30A	20A
70*	5.1	5.6	6.4	7.3	8.5	10.2	12.7	16.9	25.4
50*	4.0	4.5	5.0	5.8	6.7	8.1	10.1	13.4	20.2
35*	2.5	2.8	3.2	3.6	4.2	5.1	6.3	8.5	12.7
25	1.6	1.8	2.0	2.3	2.7	3.2	4.0	5.3	8.0
16	1.0	1.1	1.3	1.4	1.7	2.0	2.5	3.3	5.0
10	0.6	0.7	0.8	0.9	1.1	1.3	1.6	2.1	3.2
6	0.4	0.4	0.5	0.6	0.7	0.8	1.0	1.3	2.0

Maximum 1-way wire distance for 12 Volt systems, solid copper, 2% voltage drop



Note: *Wires sizes larger than 4 AWG (25 mm²) must be terminated at a splicer block located

outside of the MPPT. Use 4 AWG (25 mm²) or smaller wire to connect to the MPPT to the splicer block.



- The specified wire length is for a pair of conductors from the solar or battery source to the controller (1-way distance)

- For 24/36/48 volt systems, multiply the 1-way length in the table by 2/3/4.

RJ45 Port Definition

PIN	Function
1	RS485-A
2	RS485-B
3	Dry contact
4	Dry contact
5	GND (isolation)
6	GND (isolation)
7	+5V (isolation)
8	+5V (isolation)

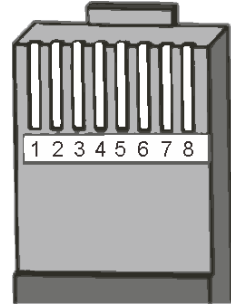

Serial Connection(String) Of Solar Panels

Voc * N = P _{Vinput} < 150Vdc												
System Voltage	Voc<23V		Voc<31V		Voc<34V		Voc<38V		Voc<46V		Voc<62V	
	Max.	Best	Max.	Best	Max.	Best	Max.	Best	Max.	Best	Max.	Best
12V	6	2	4	1	4	1	3	1	3	1	2	1
24V	6	3	4	2	4	2	3	2	3	2	2	1
36V	6	4	4	3	4	3	3	3	3	2	2	1
48V	6	5	4	4	4	3	3	3	3	2	2	2



Note: The table is the quantity(N) of solar panels in series, for reference only.

Efficiency Graphs

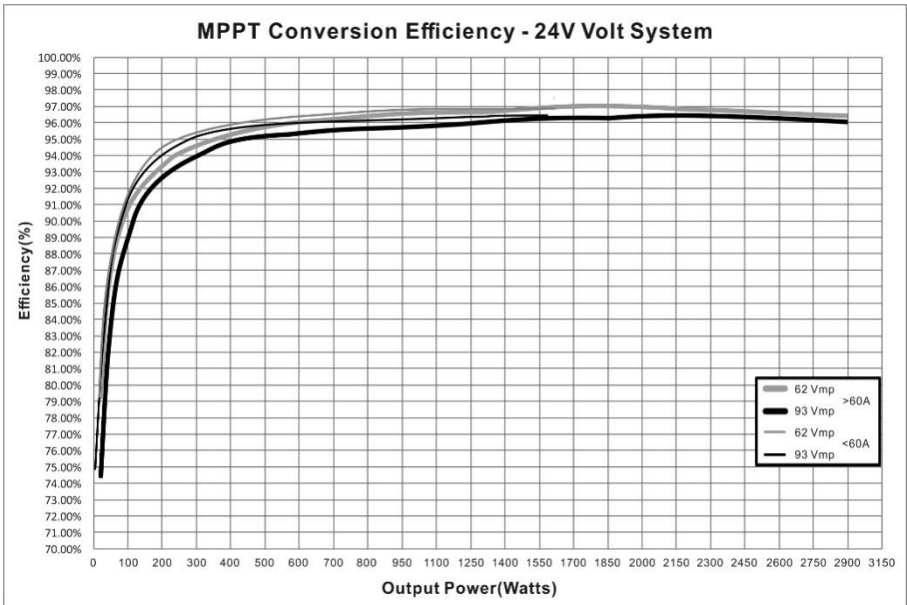
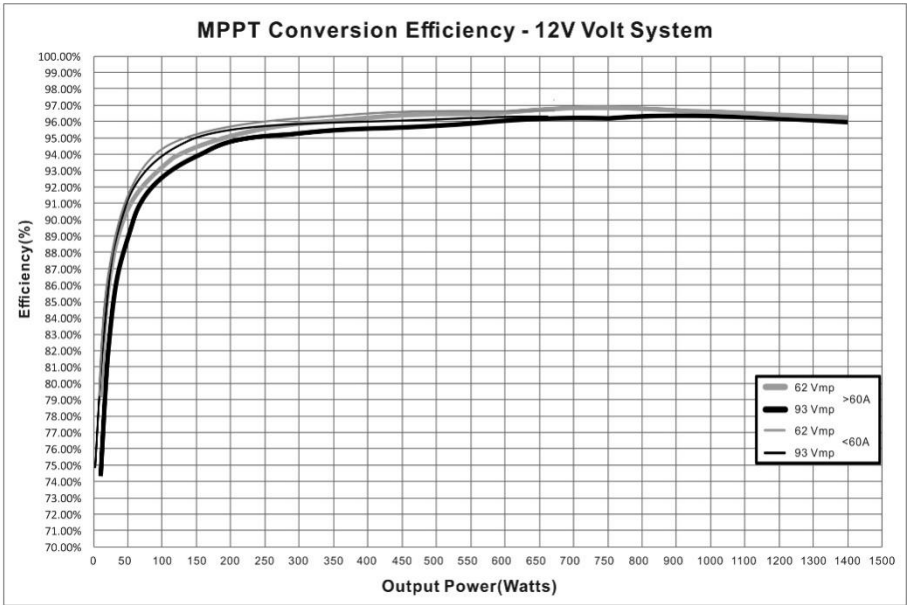

MPPT Conversion Efficiency - 36V Volt System

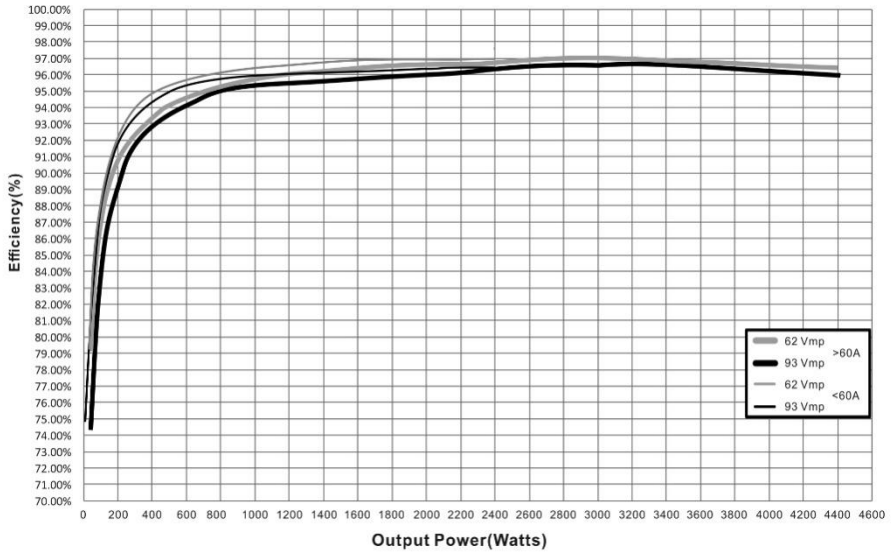

MPPT Conversion Efficiency - 48V Volt System

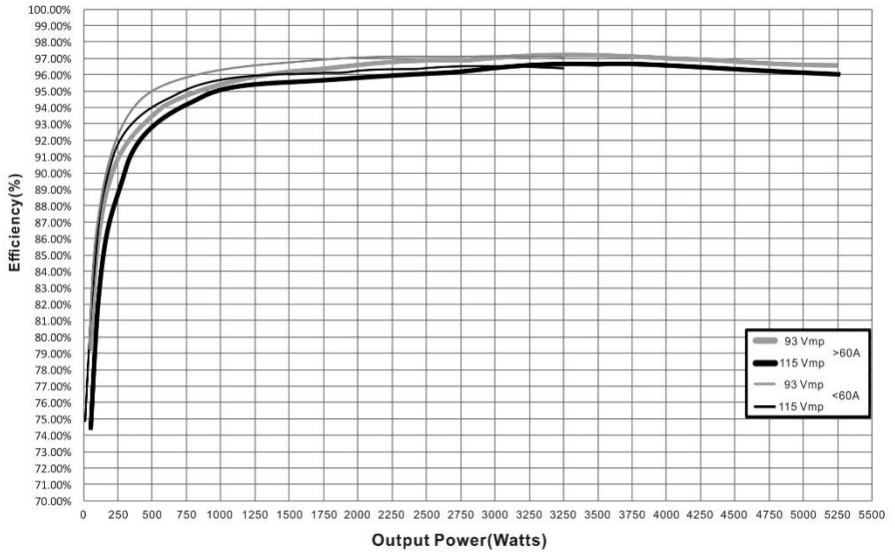

IPANDEE

Acid Li

RUNNER-RS

Solar Charging System Controller

SHENZHEN • CHINA

www.ipandee.com

 www.ipandee.com

 service@ipandee.com